

VRF

Technical Data Book

DVM S for SOUTH AMERICA
(460V, R410A, 60Hz, HP)

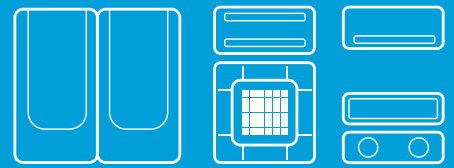

Model : AM *** JXVAJH

Nomenclature

Outdoor Units

Model Names

AM	080	J	X	V	A	J	H	/	AZ
(1)	(2)	(3)	(4)	(5)	(6)	(7)	(8)		Buyer

(1) Classification

AM	DVM
----	-----

(2) Capacity

x 1/10 HP (3 digits)

(3) Version

F	2013
H	2014
J	2015

(4) Product Type

X	Outdoor Unit
N	Indoor Unit

(5) Feature1

V	Inverter
M	DVM S Eco

(6) Feature2

A	Standard + General Temp.+ MODULE
H	High EER + Low Temp + Module

(7) Rating Voltage

F	3Ø, 208~230V, 60Hz
J	3Ø, 460V, 60Hz

(8) Mode

H	Heat Pump
R	Heat Recovery

2 Specifications

Outdoor

Type			DVM S(NEW)	DVM S(NEW)	DVM S(NEW)	DVM S(NEW)			
Model Name			AM080JXVAJH/AZ	AM100JXVAJH/AZ	AM120JXVAJH/AZ	AM140JXVAJH/AZ			
Power Supply			Ø, #, V, Hz	3,3,460,60	3,3,460,60	3,3,460,60			
Mode			-	HP	HP	HP			
Performance	Ton	Cooling	TON	6.37	7.96	9.55	11.37		
			kW	22.39	27.99	33.59	40.00		
	Capacity (Nominal)	Cooling	Btu/h	76,400	95,500	114,600	136,500		
			US RT	6.37	7.96	9.55	11.37		
		Heating	kW	25.20	31.51	37.81	44.99		
			Btu/h	86,000	107,500	129,000	153,500		
			US RT	7.17	8.96	10.75	12.79		
Power	Power Input	Cooling	kW	4.35	5.50	7.22	8.47		
				Heating	4.44	5.33	7.40	9.18	
	Current Input	Cooling	A	6.10	7.70	10.10	11.80		
				Heating	6.20	7.40	10.30	12.80	
	MCA			-	17.40	18.90	20.60	25.00	
	MFA			-	25.00	25.00	32.00	32.00	
COP	EER (Nominal Cooling)		-	5.15	5.09	4.65	4.72		
	EER (Nominal Heating, US)		-	17.60	17.40	15.90	16.10		
	COP (Nominal Heating)		-	5.68	5.91	5.11	4.90		
	Energy Grade		-	-	-	-	-		
Compressor	Type		-	SSC Scroll x 1	SSC Scroll x 1	SSC Scroll x 1	SSC Scroll x 2		
	Output		kW x n	(4.39)	(6.39)	(6.39)	(4.39 x 2)		
	Model Name		-	DS-GA046FAVASGx1	DS-GB066FAVBGSx1	DS-GB066FAVBGSx1	DS-GA046FAVASGx2		
	Oil	Type	-	PVE	PVE	PVE	PVE		
Fan	Type		-	Propeller	Propeller	Propeller	Propeller		
	Output x n		W	830x1	830x1	830x1	620x2		
	Air Flow Rate		CFM	6,003.7	6,003.7	7,769.5	9,005.6		
	External Static Pressure	Max.	Pa	78.40	78.40	78.40	78.40		
In Wg			0.31	0.31	0.31	0.31			
Piping Connections	Liquid Pipe		Ø, mm	9.52	9.52	12.70	12.70		
			Ø, inch	3/8"	3/8"	1/2"	1/2"		
	Gas Pipe		Ø, mm	19.05	22.22	28.58	28.58		
			Ø, inch	3/4"	7/8"	1 1/8"	1 1/8"		
	Discharge Gas Pipe		Ø, mm	-	-	-	-		
			Ø, inch	-	-	-	-		
	Installation Limitation	Max. Length		m	200 (220)	200 (220)	200 (220)	200 (220)	
				ft	656 (722)	656 (722)	656 (722)	656 (722)	
Max. Height			m	110 (110)	110 (110)	110 (110)	110 (110)		
			ft	361 (361)	361 (361)	361 (361)	361 (361)		
Refrigerant	Type		-	R410A	R410A	R410A	R410A		
	Factory Charging		kg	5.50	5.50	6.50	7.70		
Sound	Pressure		lbs	12.13	12.13	14.33	16.98		
	Power		dB(A)	57	58	62	61		
External Dimension	Net Weight		kg	182.5	189.5	200.5	281.0		
			lbs	402.34	417.78	442.03	619.50		
	Shipping Weight		kg	198.5	205.5	216.5	300.0		
			lbs	437.62	453.05	477.30	661.39		
	Net Dimensions (WxHxD)			mm	880x1,695x765	880x1,695x765	880x1,695x765	1,295x1,695x765	
				inch	34.65x66.73x30.12	34.65x66.73x30.12	34.65x66.73x30.12	50.98x66.73x30.12	
		Shipping Dimensions (WxHxD)			mm	948x1,887x832	948x1,887x832	948x1,887x832	1,363x1,887x832
					inch	37.32x74.29x32.76	37.32x74.29x32.76	37.32x74.29x32.76	53.66x74.29x32.76
Operating Temp. Range	Cooling		°C	-5.0 ~ 48.0	-5.0 ~ 48.0	-5.0 ~ 48.0	-5.0 ~ 48.0		
			°F	23.0 ~ 118.4	23.0 ~ 118.4	23.0 ~ 118.4	23.0 ~ 118.4		
	Heating		°C	-25.0 ~ 24.0	-25.0 ~ 24.0	-25.0 ~ 24.0	-25.0 ~ 24.0		
			°F	-13.0 ~ 75.2	-13.0 ~ 75.2	-13.0 ~ 75.2	-13.0 ~ 75.2		

1) Nominal cooling capacities are based on;

Indoor temperature : 27°C DB, 19°C WB / Outdoor temperature : 35°C DB, 24°C WB, Refrigerant piping : 7.5m , Level differences : 0m

2) Nominal heating capacities are based on;

Indoor temperature : 20°C DB, 15°C WB / Outdoor temperature : 7°C DB, 6°C WB, Refrigerant piping : 7.5m, Level differences : 0m

- Sound level was acquired in an anechoic room. Thus actual noise level may be different depending on the installation conditions.

- Specifications may be subject to change without prior notice.

- If outdoor unit is located in a higher position than indoor unit, level difference is 110m or under.

(If the level difference is higher than 50m, make a decision by PDM kit installation Guide software whether the PDM kit should be installed or not.)

- PDM kit: Pressure Drop Modulation kit

When the outdoor unit is below the indoor unit & the level differences are 40m or more, contact your local dealer for more information.

/ Dimensional drawing

Outdoor

AM080JXVAJH/AZ, AM100JXVAJH/AZ, AM120JXVAJH/AZ

Units : mm / inches

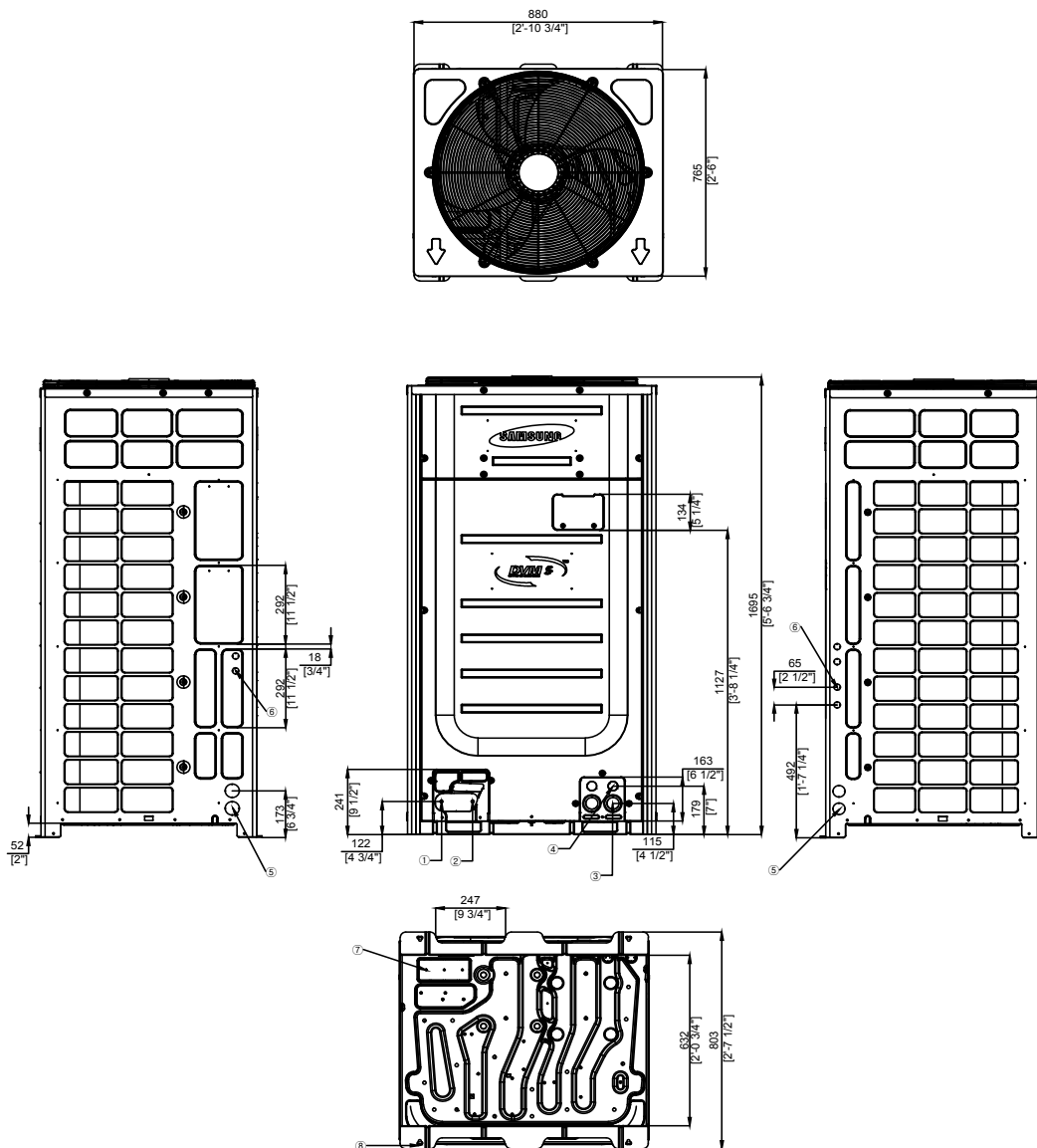

Table of descriptions

1	Refrigerant gas pipe	7	Knock-out Hole for Ref. Piping
2	Refrigerant liquid pipe	8	Anchor Bolt Hole
3	Power wiring conduit	9	
4	Communication wiring conduit	10	
5	Power wiring conduit	11	
6	Communication wiring conduit	12	

Electrical wiring diagram

Outdoor

AM080JXVAJH/AZ, AM100JXVAJH/AZ, AM120JXVAJH/AZ, AM140JXVAJH/AZ, AM160JXVAJH/AZ, AM180JXVAJH/AZ, AM200JXVAJH/AZ
AM220JXVAJH/AZ

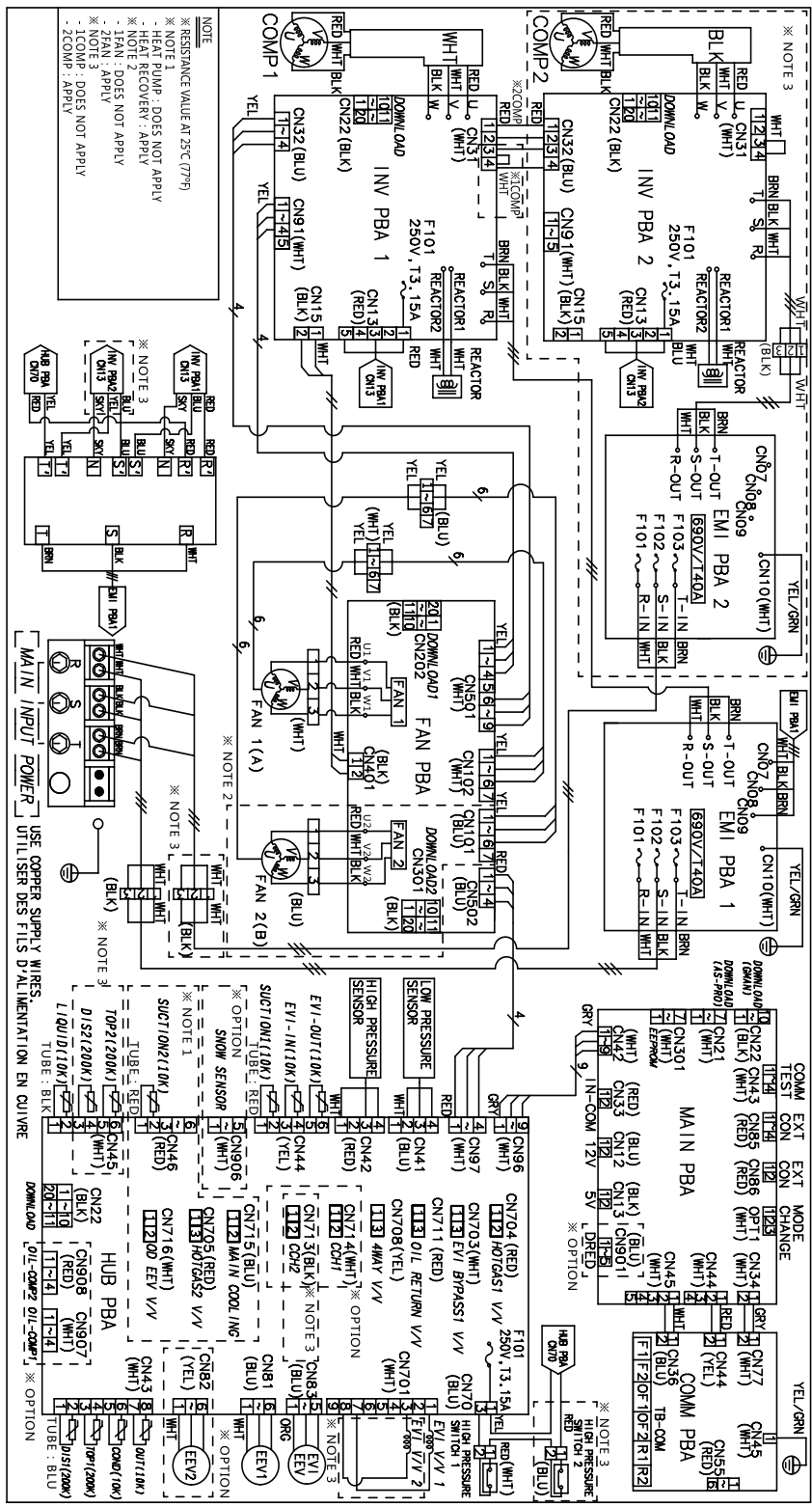

↑ Sound pressure level

Outdoor

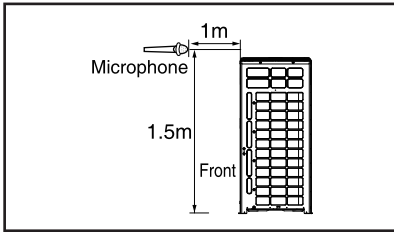

Unit: dB(A)

Model	Pressure
AM080JXVAJH/AZ	57
AM100JXVAJH/AZ	58
AM120JXVAJH/AZ	62
AM140JXVAJH/AZ	61

Note

Measuring place: Anechoic chamber (conversion value)

These operation values were obtained in an anechoic room. Sound pressure level will vary depending on a factors such as the construction of the particular room where the equipment is installed.

Operation sound level may differ depending on operation and ambient conditions.

NC curve

1) AM080JXVAJH/AZ

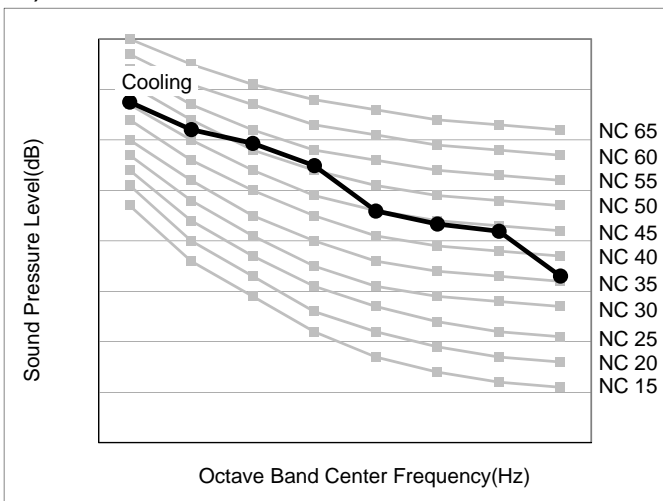

2) AM100JXVAJH/AZ

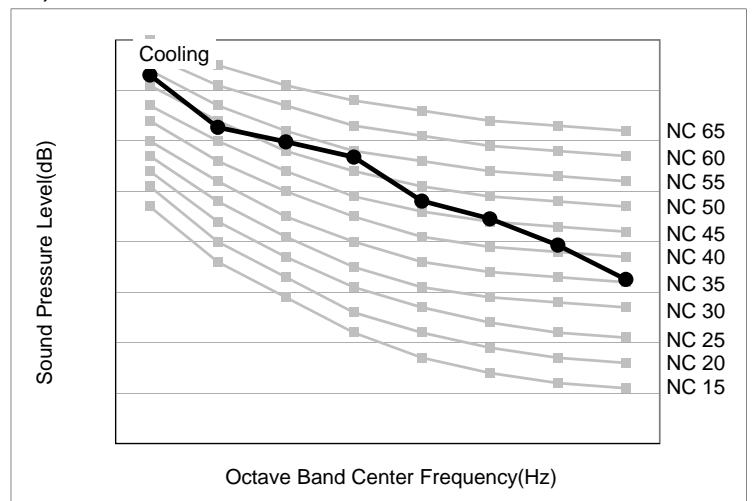

3) AM120JXVAJH/AZ

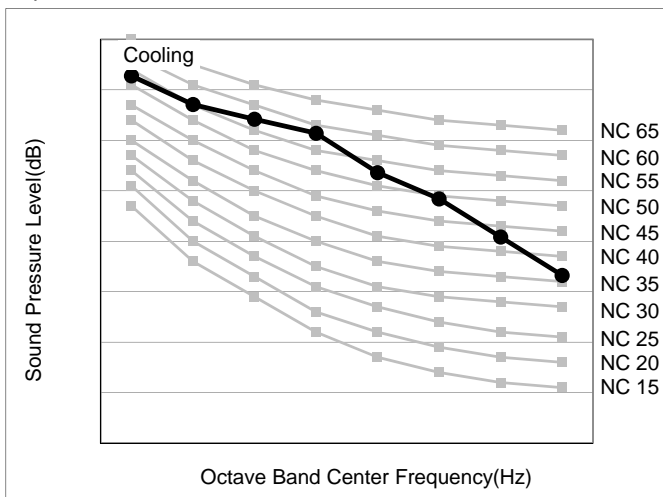

4) AM140JXVAJH/AZ

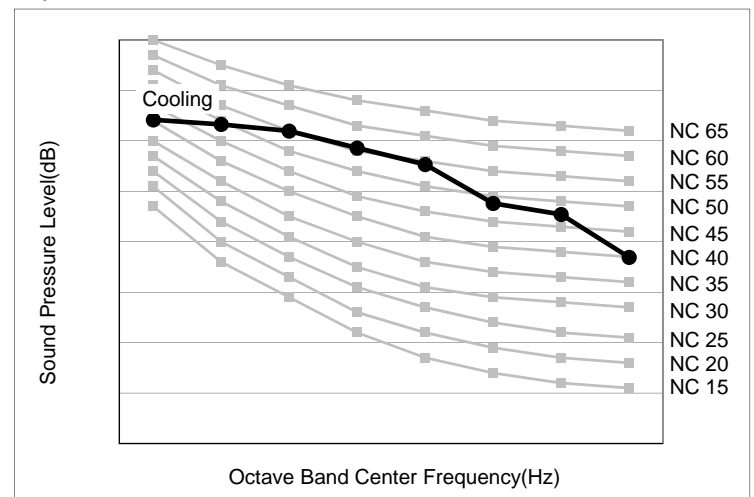

i Cycle diagram

Outdoor

AM080JXVAJH/AZ, AM100JXVAJH/AZ, AM120JXVAJH/AZ

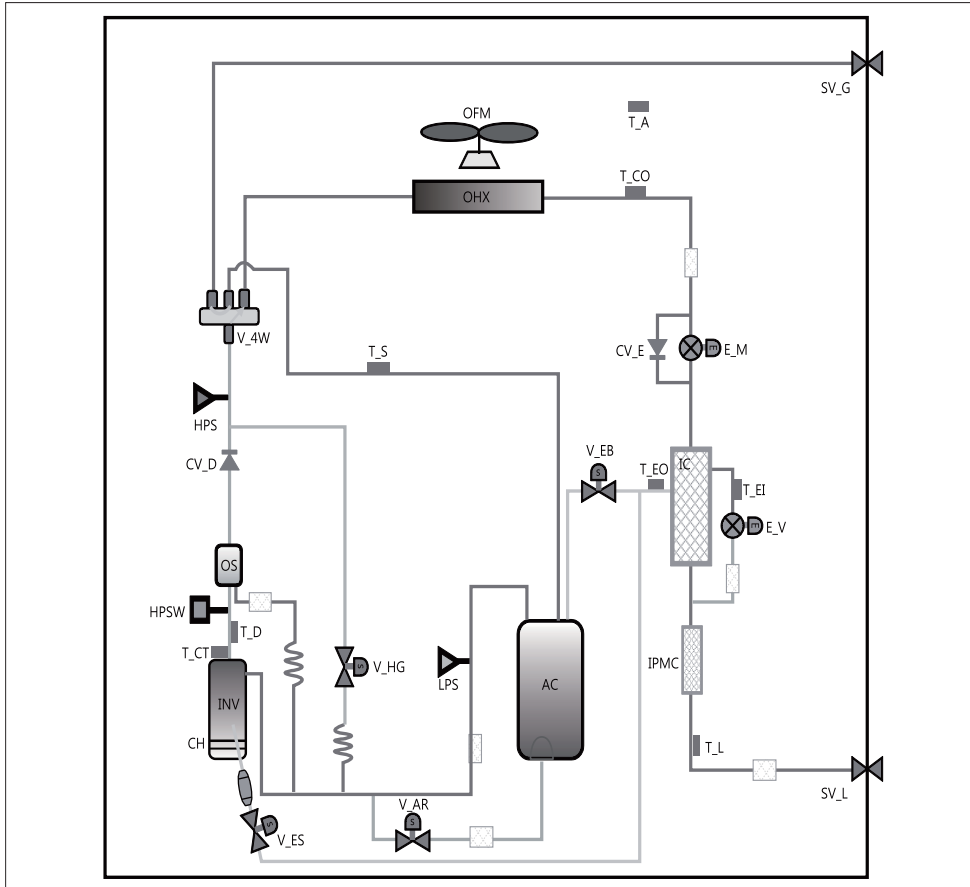

Classification	Description
INV	Inverter Compressor
OFM	Outdoor Fan Motor
OHX	Outdoor Heat Exchanger
AC	Accumulator
OS	Oil Separator
IC	Intercooler
IPMC	IPM Cooler
CH	Crank Case Heater
HPS	High Pressure Sensor
LPS	Low Pressure Sensor
HPSW	High Pressure Switch
E_M	Main EEV
E_EV	EVI EEV
V_ES	EVI Solenoid Valve
V_EB	EVI Bypass Valve

Classification	Description
V_HG	Hot Gas Bypass Valve
V_4W	4way Valve
V_AR	Accumulator Oil Return Valve
CV_E	EEV Bypass Check Valve
CV_D	Discharge Check Valve
T_D	Discharge Temperature Sensor
T_S	Suction Temperature Sensor
T_CO	Condenser Out Temperature Sensor
T_EI	EVI In Temperature Sensor
T_EO	EVI Out Temperature Sensor
T_L	Liquid Tube Temperature Sensor
T_CT	Compressor Top Temperature Sensor
T_A	Ambient Temperature Sensor
SV_G	Gas Pipe Service Valve
SV_L	Liquid Pipe Service Valve

SAMSUNG

2016.12
Ver.1.4

Samsung Electronics Co., LTD.
B2B PM / SE

Head Office (Suwon Korea) 129, Samsung-Ro, Yeongtong-Gu, Suwon City, Gyeonggi-Do, Korea 443-742
Website : www.samsung.com Email : airconditioner@samsung.com
Images and data in this book may subject to change without prior notice.

SAMSUNG